

Valveco040...050: 2-way regulating valve for dynamic hydraulic calibration

How energy efficiency is improved

Automatic dynamic hydraulic calibration with the SAUTER Valveco regulating valve provides correct supply to the consumers and a reduction of temperature fluctuations in the room, so that energy use is more accurate and more efficient.

Areas of application

This multi-function valve is used to control the volume flow accurately in air-conditioning, ventilation and heating equipment, such as fan-coil units, chilled beams, central underfloor heating systems, air recirculation systems and segments of installations in conjunction with the AVM115F901 and AVM115SF901 actuators.

Features

- Regulating valve with three functions: control, preset maximum volume, automatic flow regulation
- Nominal diameter DN 40 and DN 50
- Large range 1500...10000 l/h
- Simple presetting of maximum volume flow without dismantling the actuator
- Control range 20...400 kPa = max. Δp across the valve
- Linear characteristic
- Pressure measurement nipple on valve (for optimising)
- When the spindle is retracted, the valve is closed
- Closes against the pressure
- Slight adaptation of the tried-and-tested SAUTER actuator technology

Technical description

- Regulating valve with male thread as per DIN EN ISO 228-1
- Flat-sealing regulating valve
- Differential pressure across the regulating unit is kept constant; valve authority 1
- Valve body made of gunmetal
- Valve cone made of dezincification-resistant (DZR) brass
- Valve stem made of DZR brass
- Seals: PTFE, EPDM
- Temperature range of medium $-10...120\text{ }^{\circ}\text{C}$

Products

Type	Nominal diameter (DN)	Volume flow range (l/h)	Control range min Δp ... max Δp (kPa)	Connection	Weight (kg)
VCL040F200	40	1500...7500	20...400	G2 ¼ B	5.7
VCL050F200	50	2500...10000	20...400	G2 ¼ B	6.4

Technical data

General parameters

Nominal pressure	PN 16
Maximum operating pressure	16 bar

Valve specifications

Valve characteristic	linear
Valve stroke	
VCL040/VCL050	max. 10.0 mm
Leakage rate	0.01% of k_{vs}

Permitted operating conditions

Operating temperature	$-10...120\text{ }^{\circ}\text{C}$
-----------------------	-------------------------------------

Additional information

Fitting instructions	MV P100009045
assembled with AVM1x5	MV 506065
Material declaration	MD 57.001
Dimension drawing	M11478 B12352

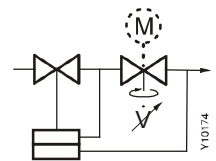
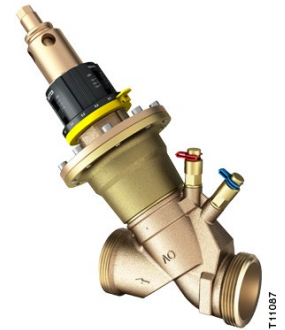

Accessories

Type	Description
0361951 040*	1 screw fitting for male thread with flat seal, DN 40
0361951 050*	1 screw fitting for male thread with flat seal, DN 50
0560332040*	Dirt trap in gunmetal, $-10...+150\text{ }^{\circ}\text{C}$, mesh aperture 0.8 mm, DN 40
0560332050*	Dirt trap in gunmetal, $-10...+150\text{ }^{\circ}\text{C}$, mesh aperture 0.8 mm, DN 50

*) Dimension drawing or wiring diagram is available under the same number

Combination of VCL with 230 V (2-/3-point) electric valve actuator

Actuator Running time: Input:				AVM115F901 160 s 2-/3-point
Valve	Closes against the pressure			
	Δp_{\max}	Δp_s	close/off pressure	
VCL040F200	4.0	–	4.0	
VCL050F200	4.0	–	4.0	

Combination of VCL with 24 V (continuous, 2-/3-point) electric valve actuator

Actuator Running time: Input:				AVM115SF901: 80/160 s 2-/3-point, 0...10 V
Valve	Closes against the pressure			
	Δp_{\max}	Δp_s	close/off pressure	
VCL040F200	4.0	–	4.0	
VCL050F200	4.0	–	4.0	

Complete type designation for valve and actuator, each with F-variant

Valve: For F variant, technical data and accessories, see table of valve types

Actuator: For F variant, technical data, accessories and fitting position, see section 55

Example: VCL040F200 / AVM115SF901

Δp_{\max} [bar]= Maximum permitted pressure difference across the valve at which the actuator can still reliably open and close the valve. Figures for static pressure of 6 bar; at a static pressure of 16 bar, these values are reduced by 15%

Δp_s [bar]= Maximum permitted pressure difference across the valve, in the event of a malfunction, at which the actuator can close the valve.

close/off pressure [bar]= Pressure difference across the valve, in control mode, which can overcome the force of the actuator. A reduced service life is to be expected in this range. Cavitation, erosion and pressure surges may damage the valve. The values apply only in the assembled state, i.e. as a unit, with the valve mounted on the actuator.

Function

When the stem is extended, the valve is closed. The valve can be controlled with the AVM115F901 and AVM115SF901 valve actuators.

The valve can be continuously set in any position using the SUT AVM115SF901 valve actuator with a control voltage of 0...10 V.

The mode of operation (valve opens or closes as the control voltage increases) can be set on the valve actuator by changing the terminal assignment.

The linear characteristic allows optimal control together with a continuous 0...10 V actuator.

Description

This innovative design combines a dynamic volume flow controller (with a maximum volume flow that can be preset), an internal differential pressure controller and a regulating valve with electrical regulation which is independent of the set volume flow. Presetting is also possible with the actuator fitted.

The dynamic controller keeps the pressure across the regulating valve constant, regardless of pressure fluctuations in the system. Thanks to this design, the volume flow is automatically limited to the preset maximum value with 100 per cent valve authority.

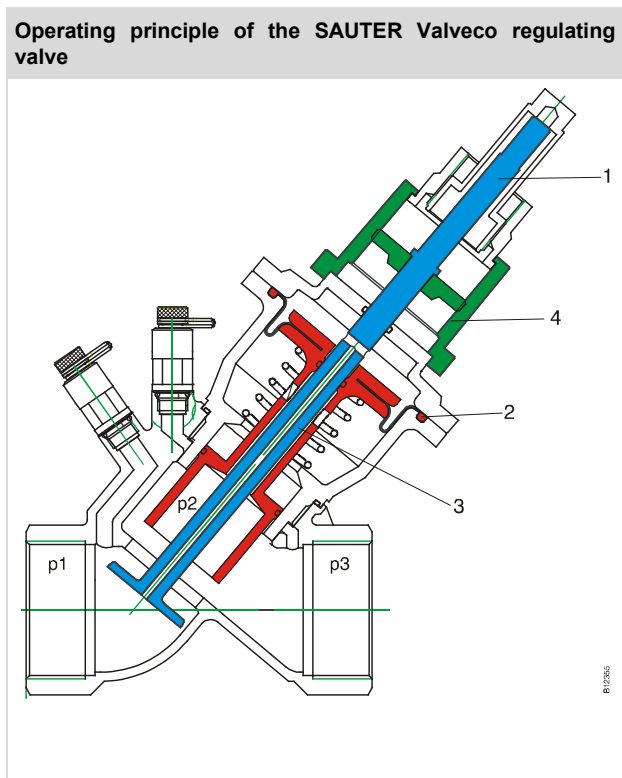

Key

1	Regulating unit for compensating the differential pressure
2	Membrane for compensating the differential pressure with compensation mechanism. Keeps the differential pressure constant across the regulating unit and the preset
3	Pressure channel
4	Regulating unit for setting or restricting the volume flow

The combination of dynamic hydraulic calibration and dynamic regulation in the SAUTER Valveco simplifies the work of planning engineers and installers. No time is wasted on initial measurement or regulation of plants, and the energy supply for the existing plant is not affected in the event of extensions.

Example of volume flow

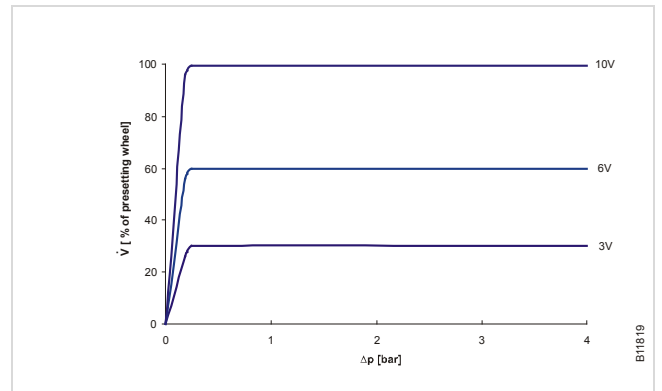

Example function: DN 40 VCL040F200 with preset max. volume flow 7500 l/h
 Volume flow as a function of the control voltage (0...10 V continuous control) and the differential pressure
 Control voltage: 3 V, 6 V and 10 V

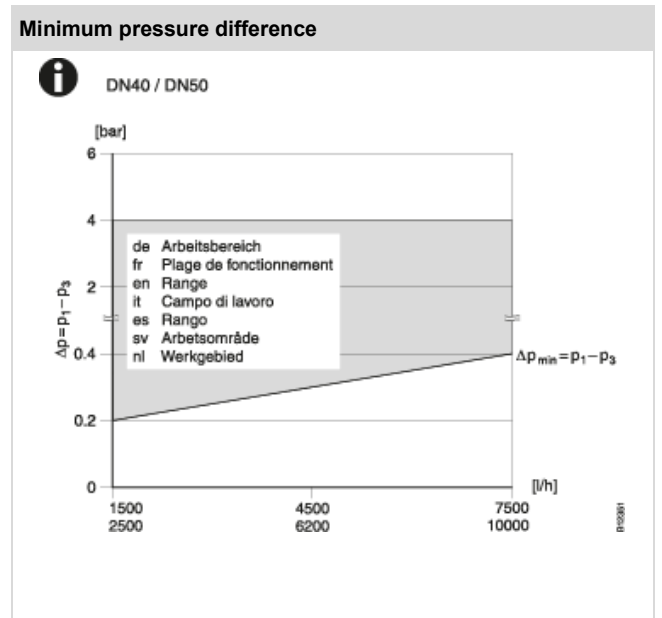

In the diagram, the required minimum pressure differential (min. Δp) across the valve can be determined. The system can be set precisely to this value using the two pressure measurement nipples.

Design benefits

- Minimal labour time is needed in order to specify the components for hydraulic calibration (only the volume flow data is needed)
- The valve authority does not have to be calculated
- Less energy is consumed because the design volume flow is guaranteed
- Maximum flexibility whenever changes have to be made to the system

Installation benefits

- No additional regulating valves are required for the controller in question
- Total number of valves required is reduced due to the multi-function capability
- Reduced labour time, no initial regulation, simple and accurate method of presetting the volume flow
- Measurement of differential pressure is possible
- Built-in shut-off function
- The set volume flow value can be secured by applying a local seal

Operating benefits

- Constant high level of comfort for end users thanks to high-precision volume flow control
- Pressure fluctuations in the system are compensated by the differential pressure controller (interference variable: input pressure); this substantially reduces temperature fluctuations in the controlled room/area (reduced energy consumption). Secondary effect: The required running times are reduced, thereby prolonging the actuator's service life.
- The control range is always precisely regulated up to 400 kPa across the valve.

Engineering and fitting notes

To prevent contamination of the water (e.g. weld beads and rust particles, etc.) and to prevent damage to the differential pressure controller, dirt filters must be fitted (e.g. on each floor or line) (see accessories; observe the temperature range and application, depending on the type). Requirements for water quality are as per VDI 2035.

All SAUTER Valveco valves must be used in closed circuits only. An excessively high oxygen mixture can destroy the regulating valves in open circuits. To avoid this, an oxygen binding agent must be used; compatibility must be clarified with the manufacturer regarding corrosion. The materials shown in the list below may be used.

The fittings are usually insulated in the plants. However, note that no insulation is applied up to the actuator housing.

To prevent any disturbing flow noise from being audible in quiet rooms, the pressure difference across the valve must not exceed 70% of the indicated maximum values.

To prevent damage resulting from non-usage, the valves should be operated for a short time at regular intervals. We recommend performing a stroke movement of at least 10% every month.

To increase the functional reliability of the valve, the system must conform to DIN EN 14336 (heating systems in buildings). DIN EN 14336 states, amongst other things, that the system has to be flushed through before being put into service.

Application with water

When using water mixed with glycol or an inhibitor, the compatibility of the materials and seals used in the control valve should be clarified with the manufacturer just to be on the safe side. The materials shown in the list below may be used. When glycol is used, we recommend using a concentration of between 20% and 50%.

Fitting position

The final control element can be fitted in any position except upside down. The ingress of condensate, drops of water etc. along the spindle and into the actuator should be prevented.

Mounting and setting

The maximum design volume flow can be set both before and after the actuator is fitted, using the preset scale located at the top of the valve. No conversion table is required. The scale on the preset wheel indicates a recommended value for the flow rate (x 10l/h or x 0.1 m³/h).

The installer can secure the set maximum volume flow by applying a seal.

Technical information	
Pressure and temperature data	EN 764, EN 1333
Fluidic parameters	EN 60534, page 3
Technical manual: 'Regulating units'	7000477003
Parameters, fitting notes, control, general information	Applicable regulations as per EN, DIN and UVV, plus AD information sheets and TRD guidelines
Declaration of conformity (no CE identification)	As per Pressure Equipment Directive 97/23/EC, article 3.3 for fluid group 2

Additional information
Valve body made of gunmetal with cylindrical male thread as per ISO 228/1, class B, flat seal on body. Stuffing box with O-ring of EPDM (ethylene-propylene).

Material designations

	DIN material no.	DIN code
Valve body	CB 499 K	Cu Sn5 Zn5 Pb2-C-GS
Valve seat	CB 499 K	Cu Sn5 Zn5 Pb2-C-GS
Stem	CW 602 N	Cu Zn 36 Pb2 As
Valve cone	CW 602 N	Cu Zn 36 Pb2 As
Stem seal	PTFE	
Stuffing box	CW 602 N	Cu Zn 36 Pb2 As

Dimension drawing

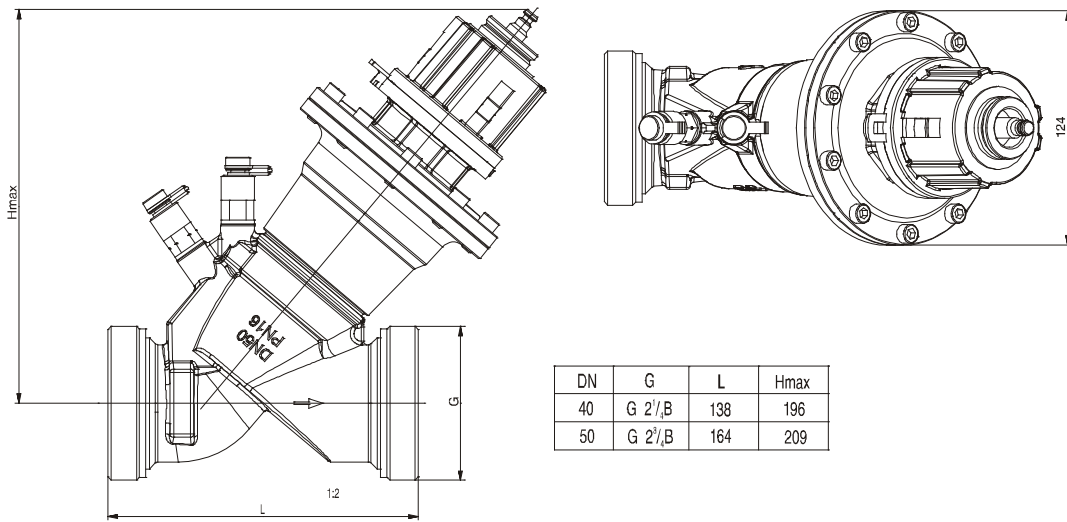

B123852

Accessories

361951

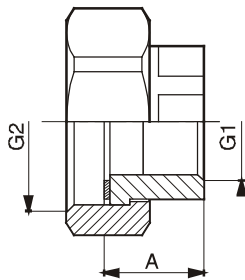

DN	A	G1	G2
40	33	Rp 1 1/2	G 2 1/4
50	32.3	Rp 2	G 2 3/4

M08806b