

AVM 234S: Valve actuator with SUT positioner

How energy efficiency is improved

Automatic adaptation to valve, precision activation and high energy efficiency with minimal operating noise

Features

- Operation of 2-way or 3-way valves of type series VQD/BQD and VQE/BQE, as well as V/BUG, V/BUS, VUP and V/B6R DN 15...150
- For controllers with constant output (0...10 V or 4...20 mA) or switching output (2-point or 3-point control)
- Stepping motor with SAUTER Universal Technology (SUT) electronic control unit and electronic, force-dependent cut-off
- Simple assembly with valve; spindle is automatically connected after control voltage is applied (patented system)
- Automatic detection of applied control signal (constant or switched); indicated by two LEDs
- Coding switches for selecting characteristic and running time
- Type of characteristic (linear/quadratic/equal-percentage) can be set on the actuator
- Automatic adaptation to the stroke of the valve (min. valve stroke 8 mm, max. valve stroke 49 mm). The measured stroke is saved and is not lost even in the event of a power failure
- Direction of operation can be selected via screw terminals when making the electrical connection
- Crank handle for external manual adjustment with motor cut-off and as trigger for a re-initialisation
- Numerous adaptors enable the unit to be fitted onto non-SAUTER valves
- Power supply 230 V with module or direct connection for 24 V~ / 24 V=; continuous activation also admissible with 230 V
- Maintenance-free gear unit made of sintered steel; gearbox base-plate made of steel
- Mounting column made of stainless steel; mounting bracket made of cast light alloy for fitting the valve
- Electrical connections (max. 2.5 mm²) with screw terminals
- Three break-out cable inlets for M20 × 1.5 (2×) and M16 × 1.5
- Fitting vertically upright to horizontal, not suspended



AVM234SF132

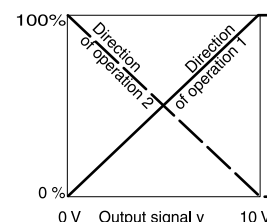

Technical data

Power supply

Power supply 24 V~	±20%, 50...60 Hz
Power supply 24 V=	±15%
Power supply 230 V~	±15% (with accessories)
Power consumption ¹⁾	10 W/18 VA

Parameters

Running time	2/4/6 s/mm
Actuating power	2500 N
Actuator stroke	0...49 mm
Response time for 3-point	200 ms

Positioner

Control signal 1	0...10 V, R _i > 100 kΩ
Control signal 2	4...20 mA, R _i = 50 Ω
Positional feedback signal	0...10 V; load > 2.5 kΩ
Starting point U ₀	0 or 10 V
Control span ΔU	10 V
Switching range X _{sh}	300 mV

Ambient conditions

Admissible ambient temperature	-10...55 °C
Admissible ambient humidity	< 95% rh, no condensation
Temperature of medium ²⁾	Max. 130 °C (180 °C or 240 °C with accessories)

¹⁾ Choose transformers for this value, otherwise malfunctions may occur

²⁾ For higher temperatures of the medium (180 °C or 240 °C), use an adaptor (see accessories)



Construction		
Weight		4.1 kg
Housing		Two-part, yellow
Housing material		Fire-retardant plastic

Standards and directives		
Type of protection		IP 66 (EN60529)
Protection class		III (IEC 60730)
EMC directive 2004/108/EC ³⁾		EN 61000-6-2, EN 61000-6-4
Low-voltage directive 2006/95/EC		EN 60730-1, EN 60730-2-14
Over-voltage categories		III
Degree of contamination		III

Overview of types

i Actuator for valves: VQD/BQD, VQE/BQE, VUG/BUG, VUP, VUS/BUS

i Actuator with assembly kit (see accessories) for valves: V6R, B6R

Type	Properties
AVM234SF132	Valve actuator with SUT positioner
AVM234SF132-5	Valve actuator, positioner 24V~ for DN 15...50, V6*/B6*
AVM234SF132-6	Valve actuator, positioner 24V~ for DN 65...150, V6*/B6*

Accessories

Type	Description
0313529001	Split-range unit for adjusting sequences, fitted in separate junction box

Modules can be added for 2-point/3-point and continuous activation; additional power 2 VA

Type	Description
0372332001	230 V ±15%, supply voltage
0372332002	100 V ±15%, supply voltage

Auxiliary change-over contacts (2 each) 12...250 V~

Type	Description
0372333001	Infinitely variable, min. 100 mA and 12 V permissible load 6(2) A
0372333002	Gold-plated contacts, from 1 mA, to max. 30 V, wider range 3(1) A
0372334001	Potentiometer, 2000 Ω, 1 W; 24 V
0372334002	Potentiometer, 130 Ω, 1 W; 24 V
0372334006	Potentiometer, 1000 Ω, 1 W; 24 V
0372336180	Adapter (required when temperature of the medium is 130...150 °C) from DN 65
0372336240	Adaptor (required when temperature of the medium is 180...240 °C)

Mounting set for AVM234SF132 on SAUTER valves (no adaptor needed for 0372338 002)

Type	Description
0372338001	V/B6 to DN 50, V/BXD, V/BXE, to DN 50, stroke 14 mm
0372338002	V/B6 DN 65...150, V/BXD, V/BXE from DN 65, stroke 40 mm
0372338003	Conversion kit from AV*2*4SF132-5 to standard actuator AV*2*4SF132
0372338004	Conversion kit from AV*2*4SF132-6 to standard actuator AV*2*4SF132

Adapter set for non-SAUTER valves

Type	Description
0372376010	Siemens with 20 mm stroke or Ø 10 mm spindle
0372376014	Siemens with 40 mm stroke or Ø 14 mm spindle
0372377001	Johnson Controls DN 15...150, 14, 25, 40 mm stroke, Ø 10, 12, 14 mm spindle
0372378001	Honeywell with 20 mm stroke
0372378002	Honeywell with 38 mm stroke
0372386001	LDM type RY113 R/M
0372389001	ITT-Dräger, DN 15...32
0372389002	ITT-Dräger, DN 40...50
0378263001	End stop (needed for V/BXD, V/BXE DN 15...50, V/B6 DN 15 with kvs ≤ 1 m ³ /h)
0386263001	Cable screw fitting M16 × 1,5

³⁾ EN 61000-6-2: (HF immunity, limitation of feedback signal between 80 MHz and 1000 MHz criterion B, otherwise criterion A)

Type	Description
0386263002	Cable screw fitting M20 × 1.5
0372461001	Forced operation for AV×2×4S

⚡ *Adaptor: Not needed for version AV*2*4SF132-6*

⚡ *Potentiometer 130 Ω: This potentiometer must only be used as a voltage divider.*

Description of operation

Depending on the type of connection (see connection diagram), the actuator can be used as a continuous (0...10 V and/or 4...20 mA), 2-point (OPEN/CLOSE) or 3-point actuator (OPEN/STOP/CLOSE). The running time of the actuator can be set with switches S1 and S2 according to the relevant requirements. Switches S3 and S4 are used to configure the characteristic (equal-percentage, linear or quadratic).

The external crank handle enables manual positional setting. When the crank handle is folded out, the motor is switched off. After the crank handle is folded back, the target position is approached again (without initialisation). When the crank handle is folded out, the actuator remains in this position.

Intended use

This product is only suitable for the purpose intended by the manufacturer, as described in the "Description of operation" section.

All related product documents must also be adhered to. Changing or converting the product is not admissible.

Engineering and fitting notes

Condensate, dripping water, etc. must be prevented from entering the actuator along the valve spindle.

The valve is mounted directly on the actuator and fixed with screws (no further adjustments are required). The actuator is connected with the valve spindle automatically. As delivered ex works, the actuator spindle is in the middle position. The housing contains three break-out cable inlets which are broken out automatically when the cable inlet is screwed in. The concept of stepping motor/electronics enables parallel operation of multiple valve actuators of the same type. The cross-section of the power cable must be selected based on the cable length and the number of actuators. With five actuators wired in parallel and a cable length of 50 m, we recommend a cable cross-section of 1.5 mm² (power consumption of the actuator × 5).

The maximum equipment for the actuator is one 230 V module, one additional accessory component (auxiliary contact or potentiometer) and the split-range unit.

Outdoor installation

If installed outside of buildings, the devices must be additionally protected from the weather.

Initialisation and feedback signal

The actuator initialises itself autonomously when it is connected as a continuous actuator. Once a voltage is applied to the actuator for the first time, the actuator moves to the lower limit stop of the valve and thus enables automatic connection with the valve spindle. Then it moves to the upper stop and the value is detected and saved via a travel measurement system. The control signal and the feedback are adjusted to this effective stroke. In case of a power failure or the removal of the power supply, no re-initialisation is carried out. The values remain saved.

For a re-initialisation, the actuator must be connected to the power supply and there must be a constant input signal at 3u or 3i. An initialisation is triggered by folding the crank handle out and back twice within 4 s. Then the two LEDs flash red.

During initialisation, the feedback signal is inactive or equal to the value "0". Initialisation is carried out with the shortest running time. The re-initialisation is only valid when the whole process is complete.

Folding the crank handle out again interrupts this process.

If the actuator detects jamming, it reports this by setting the feedback signal to 0 V after approx. 90 s. During this time, the actuator tries to overcome the jamming. If the jamming can be overcome, the normal control function is activated again, and the feedback signal is restored.

With 2-point or 3-point control, no initialisation is performed. The feedback signal is inactive.

Connection as 2-point valve actuator (24 V)

This activation (OPEN/CLOSE) can be performed via two wires. The voltage is applied to terminals 1 and 2a. When voltage (24 V) is applied to terminal 2b, the actuator spindle moves out. After this volt-

age is switched off, the actuator moves to the opposite end position. In the end positions (valve limit stop or maximum stroke reached) or in the case of an overload, the electronic motor cut-off is activated (no limit switches).

The running times can be set using the coding switch. The characteristic cannot be selected here (the result is the characteristic of the valve). Terminals 3i, 3u and 44 must not be connected.

Connection as 3-point valve actuator (24 V)

If voltage is applied to terminal 2a (or 2b), the valve can be moved to any desired position. If voltage is applied to terminals 1 and 2b, the actuator spindle moves out. It moves in when the electrical circuit is closed via terminals 1 and 2a.

In the end positions (valve limit stop or maximum stroke reached) or in the case of an overload, the electronic motor cut-off is activated (no limit switches). The direction of the stroke can be changed by swapping the connections.

The running times are set using the coding switch. The characteristic cannot be selected here (the result is the characteristic of the valve). Terminals 3i, 3u and 44 must not be connected.

Connection with 230 V or 100...110 V as 2-point/3-point or with continuous activation of valve actuator (accessory 0372332)

The built-in positioner controls the actuator depending on controller's output signal y.

A voltage signal (0...10 V-) at terminal 3u or a current signal at terminal 3i serves as the control signal. If there is a control signal at the two terminals (3u (0...10 V) and 3i (4...20 mA)) at the same time, the input with the higher value has priority.

Direction of operation 1 (mains power supply on internal connection 2a):

When the positioning signal is increasing, the actuator spindle moves out.

Direction of operation 2 (mains power supply on internal connection 2b):

When the positioning signal is increasing, the actuator spindle moves in.

The starting point and control span are fixed. To set partial ranges, a split-range unit is available as an accessory (only for voltage input 3u) – see the split-range unit function – which is intended to be installed in the actuator.

After the connection of the power supply and the initialisation, the actuator moves to every valve stroke between 0% and 100%, depending on the control signal. Thanks to the electronics and the travel measurement system, no stroke is lost, and the actuator does not require periodic re-initialisation. When the end positions are reached, this position is checked, corrected if necessary, and saved again. It is thus possible to operate multiple actuators of the SUT type in parallel. The feedback signal $y_0 = 0...10\text{ V}$ corresponds to the effective stroke of 0 to 100%.

If the control signal 0...10 V or 4...20 mA is interrupted with direction of operation 1, the actuator spindle moves in completely, or moves out completely with direction of operation 2.

The coding switch can be used to set the characteristic of the valve. An equal-percentage or quadratic characteristic can only be generated when the actuator is used as a continuous actuator. Additional switches can be used to select the running times (with the 2-point, 3-point or continuous functions). Continuous actuation can also be used with a power supply of 230 V or 110 V (accessory required). You must ensure that the neutral wire of the controller is connected to the control voltage. The neutral wire of the power supply may only be used for the module.

LED indicator: The indicator consists of bi-colour LEDs (red / green).

Both LEDs flash red	Initialisation
Top LED lights up red	Top limit stop or "CLOSED" position reached
Bottom LED lights up red	Bottom limit stop or "OPEN" position reached
Top LED flashes green	Actuator is running, moving to "CLOSED" position
Top LED lights up green	Actuator is stopped, last direction of travel "CLOSED"
Bottom LED flashes green	Actuator is running, moving to "OPEN" position
Bottom LED lights up green	Actuator is stopped, last direction of travel "OPEN"
No LED lights up	No power supply (terminal 2a or 2b)
Both LEDs flash red and green	Actuator is in manual mode

Split-range unit (accessory 0313529)

This accessory can be built into the actuator or externally housed in an electrical junction box. Starting point U_0 and control span ΔU can be set with the potentiometer. In this way, several control units can be operated by the control signal of the controller in sequence or in a cascade. The input signal (partial range) is converted into an output signal of 0...10 V.

Additional technical information

The yellow housing, consisting of the front part, rear part and connecting lid, only serves as a cover. The DC motor, electronic control unit, load-bearing section and maintenance-free gear unit are located in the housing. The actuator spindle and the column are made of rust-proof material. The inner printed circuit boards and the gear unit are made of steel. The valve spindle guide and the valve neck coupling are made of die-cast aluminium.

Note on ambient temperatures: With a media temperature of up to 110°C in the valve, the ambient temperature is allowed to reach 60°C. With a media temperature above 110°C, the ambient temperature must not exceed 55°C. Otherwise, the intermediate piece accessory 0372336180 must be fitted.

Auxiliary change-over contacts

0372333 001

Switch rating max. 250 V~, current min. 250 mA at 12 V (or 20 mA at 20 V)
Switch rating max. 12...30 V=, current max. 100 mA

0372333 002

Switch rating max. 250 V~, current min. 1 mA at 5 V
Switch rating max. 0.1...30 V=, current 1...100 mA

If it is used one time in the range up to 10 mA or up to 50 V, the gold plating is eliminated. The switch can then only be used for a higher switch rating.

Warning

- If there is a high media temperature in the valve, the actuator columns and the spindle can attain similarly high temperatures.
- If damage can occur due to the failure of the control unit, additional protective measures must be implemented.

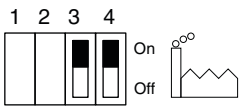
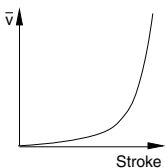
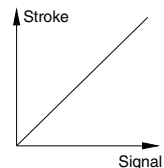
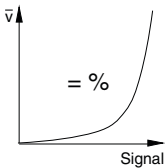
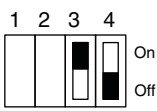
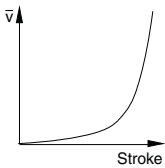
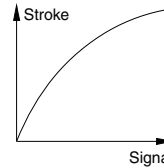
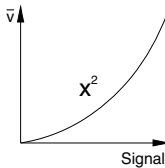
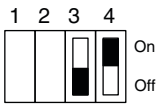
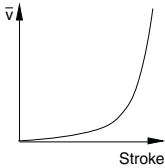
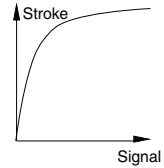
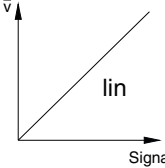
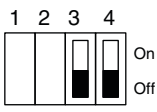
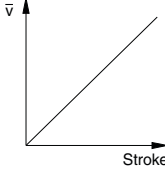
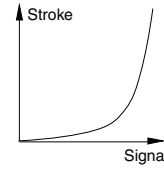
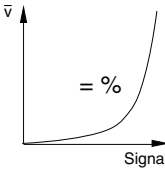
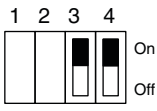
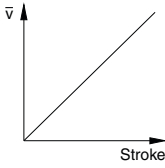
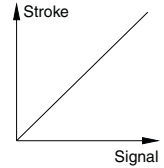
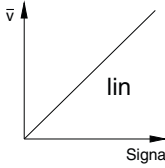
Desired character. curve	Switch coding	Characteristic curve for valve	Characteristic curve for drive	Effective on valve
Equal percentage				
Quadratic				
Linear				
Equal percentage				
Linear				

 = factory setting

Run time per mm	Switch coding	Run time for 14 mm stroke	Run time for 20 mm stroke	Run time for 40 mm stroke																
2s	<table border="1"> <tr><td>1</td><td>2</td><td>3</td><td>4</td></tr> <tr><td>On</td><td>On</td><td>Off</td><td>Off</td></tr> </table>	1	2	3	4	On	On	Off	Off	28s ± 1	40s ± 1	80s ± 4								
1	2	3	4																	
On	On	Off	Off																	
4s	<table border="1"> <tr><td>1</td><td>2</td><td>3</td><td>4</td></tr> <tr><td>On</td><td>Off</td><td>Off</td><td>Off</td></tr> </table>	1	2	3	4	On	Off	Off	Off	56s ± 2	80s ± 4	160s ± 4								
1	2	3	4																	
On	Off	Off	Off																	
6s	<table border="1"> <tr><td>1</td><td>2</td><td>3</td><td>4</td></tr> <tr><td>On</td><td>On</td><td>Off</td><td>Off</td></tr> </table> <table border="1"> <tr><td>1</td><td>2</td><td>3</td><td>4</td></tr> <tr><td>On</td><td>Off</td><td>Off</td><td>Off</td></tr> </table>	1	2	3	4	On	On	Off	Off	1	2	3	4	On	Off	Off	Off	84s ± 4	120s ± 4	240s ± 8
1	2	3	4																	
On	On	Off	Off																	
1	2	3	4																	
On	Off	Off	Off																	

 = factory setting

Disposal

When disposing of the product, observe the currently applicable local laws.

More information on materials can be found in the Declaration on materials and the environment for this product.

Connection diagram

Continuous

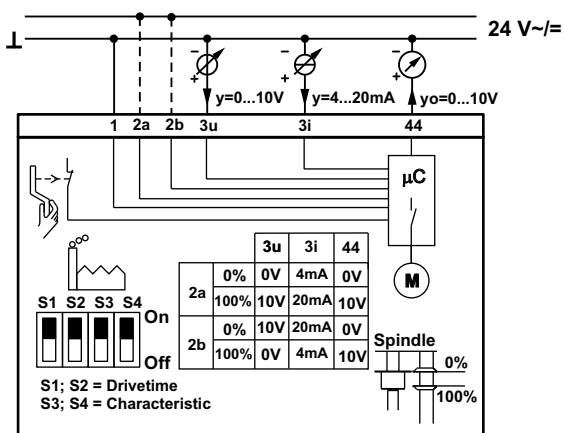

2pt

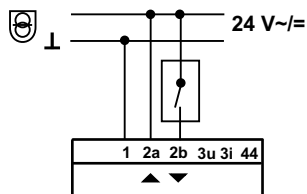

3pt

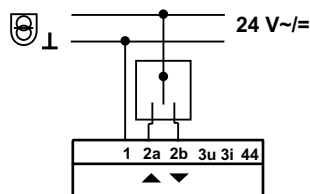

Accessories

0372332001

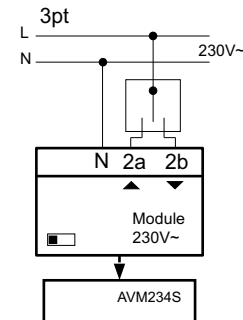
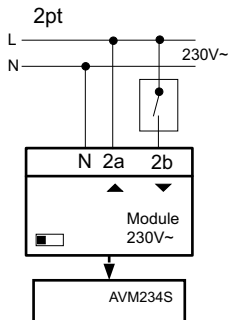
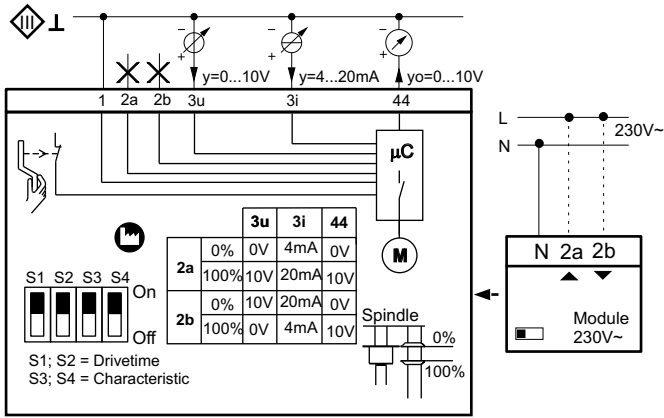

0313529

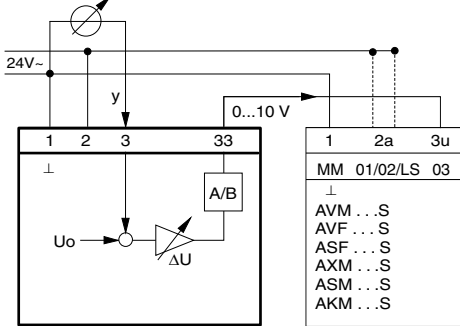

372333

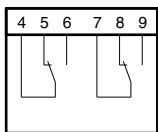

372334

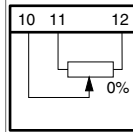

Dimension drawing

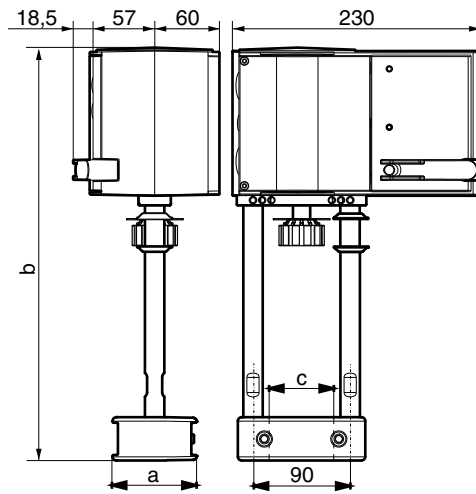

Type	a	b	c
AVM 234S F132	64	289	44
AVM 234S F132-5	58	289	38
AVM 234S F132-6	78	382	60

Accessories

0372336 180
0372336 240

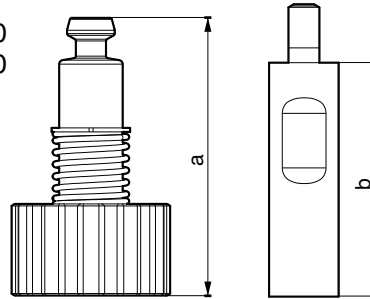

0372336	T (°C)	a (mm)	b (mm)
180	180	69,4	60
240	240	109,4	100